

RGB Encoder

Description

The CXA1145P/M encoder converts an analog RGB signal to a composite video signal.

With its built-in circuit various pulses required for an encoder, composite video outputs are obtained just by inputting the composite sync and analog RGB signal.

Features

- Single power supply 5 V
- Low power consumption (110 mW)
- Compatible both with NTSC and PAL systems
- Built-in 75Ω driver (RGB output, composite video output, composite sync output)
- Built-in oscillator for subcarrier
- External input of subcarrier is also possible.
- Built-in audio buffer circuit

Functions

- MTX circuit
- R-Y, B-Y MOD circuit
- Y/C MIX circuit
- 75Ω driver for RGB, composite video and composite sync outputs
- PAL ALT circuit
- BF generator
- Half H killer circuit
- Subcarrier oscillator
- Audio buffer circuit

Structure

Bipolar silicon monolithic IC

Package Outline

Unit: mm

CXA1145P 24 pin DIP

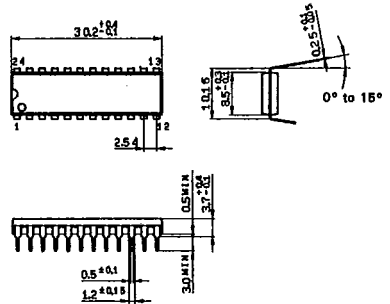

DIP-24P-01

CXA1145M 24 pin SOP

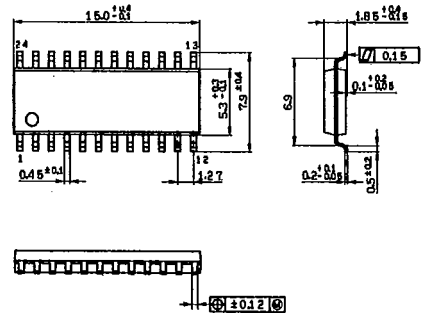

SOP-24P-L01

Absolute Maximum Ratings (Ta = 25°C)

• Supply voltage	Vcc	10	V	
• Operating temperature	Topr	-20 to +75	°C	
• Storage temperature	Tstg	-55 to +150	°C	
• Allowable power dissipation	PD	1250	mW	(CXA1145P)
		780	mW	(CXA1145M)

Recommended Operating Condition

• Supply voltage	Vcc	5 ± 0.25	V
------------------	-----	----------	---

Block Diagram and Pin Configuration

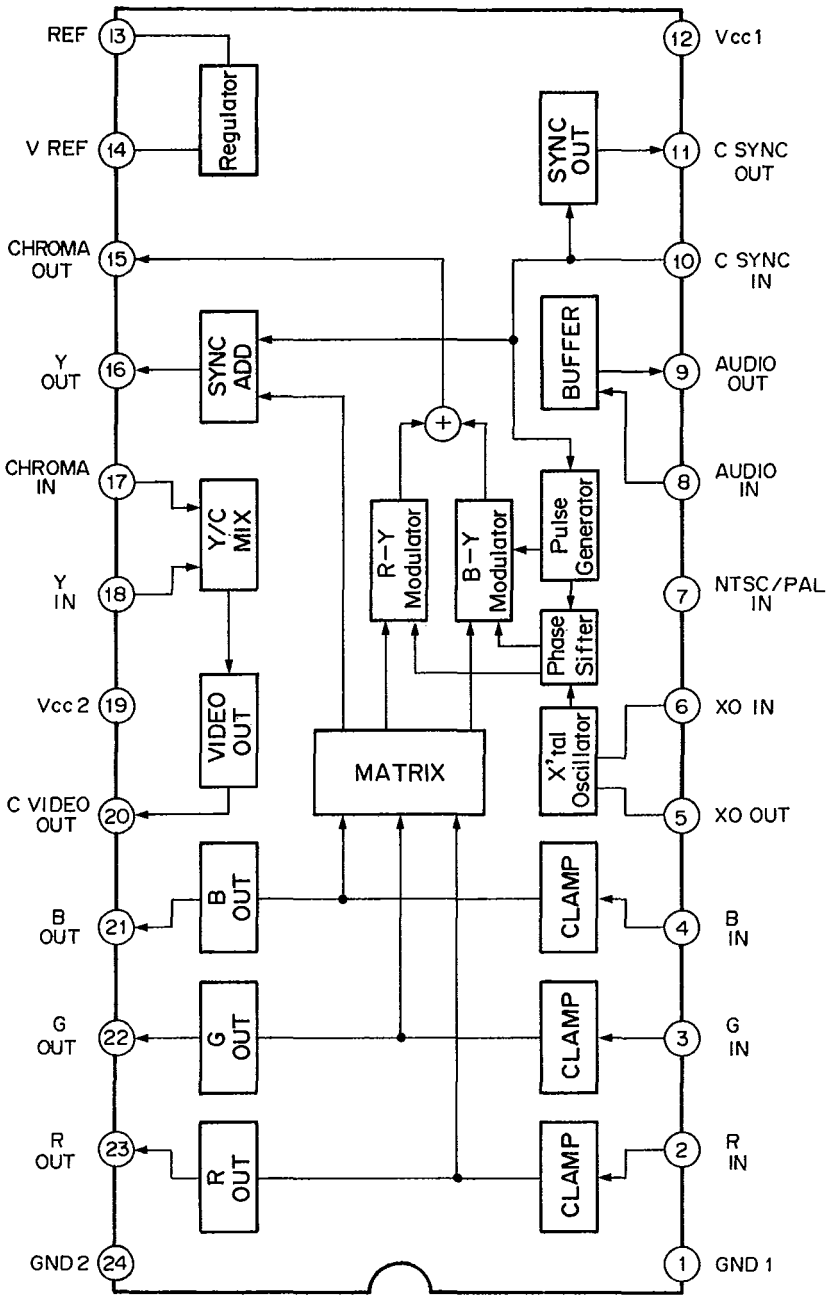

Pin Description

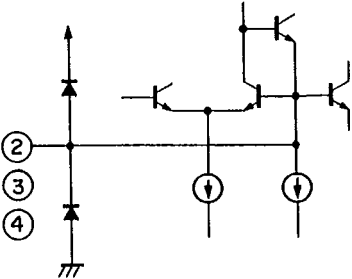
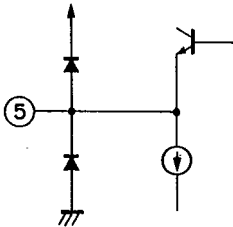
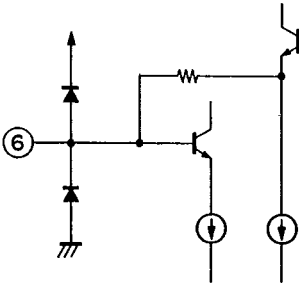
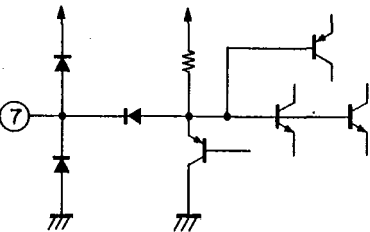
No.	Symbol	Equivalent circuit	Description
1	GND 1		GND pin for circuits other than outputs of RGB and composite video. Connect with GND 2 using an impedance as low as possible.
2 3 4	R IN G IN B IN		Input pin for the analog RGB signal. Input with 100% = 1 Vp-p. It is necessary to input with an impedance as low as possible to minimize the clamp error allowance.
5	XO OUT		Pin for the x'tal OSC. For inner oscillation, a crystal oscillator is connected. For external oscillation, input to pin 6 XO IN through a coupling capacitor.
6	XO IN		Input with the sub-carrier input level at 400 mVp-p to 1,000 mVp-p. For external oscillation, input a sine wave with enough less distortion. With much distortion, the chroma signal's phase property may deteriorate.
7	NTSC/PAL IN		Switching pin between NTSC and PAL mode. Vcc NTSC GND PAL

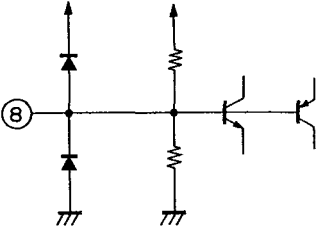
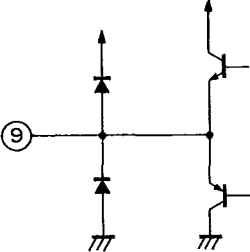
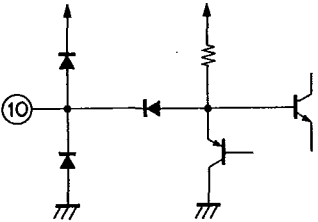
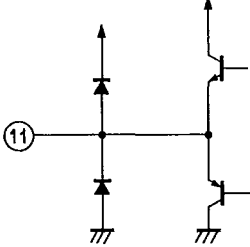
No.	Symbol	Equivalent circuit	Description
8	AUDIO IN		<p>Input pin for the audio buffer circuit. The input impedance is about 25 kΩ.</p>
9	AUDIO OUT		<p>Output pin for the audio buffer circuit.</p>
10	C SYNC IN		<p>Input pin for the composite sync signal. Input with the TTL level. L (\leq 0.8 V): Sync. H (\geq 2.0 V)</p>
11	C SYNC OUT		<p>Output pin for the composite sync signal. Capable of driving a 75Ω load direct.</p>
12	Vcc 1		<p>Power supply pin for circuits other than RGB and composite video output circuits.</p>

No.	Symbol	Equivalent circuit	Description
13	I REF		<p>Pin to determine the inner reference current. Connect to GND via a 27 kΩ resistor.</p>
14	V REF		<p>Pin for the inner reference voltage. Connect to GND with 10 μF.</p>
15	C OUT		<p>Chroma signal output pin. Connect a Band Pass Filter (BPF) between this pin and pin 17 (C IN).</p>
16	Y OUT		<p>Y signal output pin. Connect a delay line between this pin and pin 18 (Y IN).</p>
17	C IN		<p>Input pin for the chroma signal without harmonic distortion after BPF.</p>

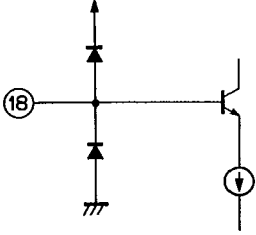
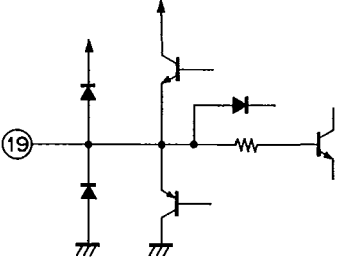
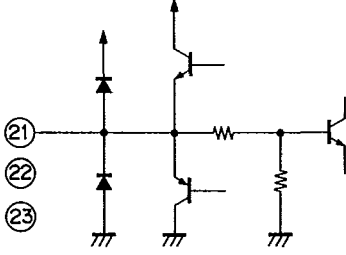
No.	Symbol	Equivalent circuit	Description
18	Y IN		Input pin for the Y signal with delay after the delay line.
19	Vcc2		Power supply pin for RGB and composite video output circuits. Decouple with a large-enough capacity as a massive current flows.
20	C V OUT		Output pin for the Y/C MIX circuit. The composite video signal is output. This output can drive a 75Ω load direct.
21 22 23	B OUT G OUT R OUT		Output pin for the analog RGB signal. Capable of driving a 75Ω load drive.
24	GND2		GND pin for RGB and composite output circuits. Connect with GND 1 using low impedance as possible.

Electrical Characteristics

Ta = 25°C, Vcc = 5V, See the Electrical Characteristics Test Circuit

Item		Symbol	Conditions	Test point	Min.	Typ.	Max.	Unit	
Consumption current 1		Icc1	S1 S2 S3 ON	I 1	15.0	19.5	27.9	mA	
Consumption current 2		Icc2	SG5 DC = 2.0V	I 2	6.3	8.2	11.7	mA	
RGB output voltage		Vo(R)	RIN = 1Vp-p, f = 200 kHz, Fig. 1	F	0.64	0.71	0.78	Vp-p	
		Vo(G)	GIN = 1Vp-p, f = 200kHz, Fig. 1	E					
		Vo(B)	BIN = 1Vp-p, f = 200kHz, Fig. 1	D					
RGB output frequency response		fc(R)	Frequency when an output becomes -3 dB with the output of f = 200 kHz in Fig. 1 set to 0 dB.	F	5.0			MHz	
		fc(G)		E					
		fc(B)		D					
Composite video output: Sync level		Vo (CS)	S6 ON, Fig. 2	C	0.26	0.29	0.33	Vp-p	
R 100%: Y level		Vo (YR)	S1 S6 ON, Fig. 2	C	0.189	0.21	0.245	V	
G 100%: Y level		Vo (YG)	S2 S6 ON, Fig. 2	C	0.378	0.42	0.482	V	
B 100%: Y level		Vo (YB)	S3 S6 ON, Fig. 2	C	0.072	0.08	0.092	V	
White 100%: Y level		Vo (YW)	S1 S2 S3 S6 ON, Fig. 2	C	0.64	0.71	0.82	V	
M I X A M P	Voltage gain	Y	Gv(Y)	S6 ON, Fig. 3	C	9	10	11	dB
		C	Gv(C)	S5 ON, Fig. 3	C				
	Frequency response	Y	fc(Y)	S6 ON, Fig. 3	C	5.0			MHz
		C	fc(C)	S5 ON, Fig. 3	C				
Differential gain		DG	S5 S6 ON, Fig. 4	C			3.0	%	
Differential phase		DP	S5 S6 ON, Fig. 4	C			3.0	deg	
Burst level		Vo (BN)	Fig. 5	C	0.26	0.29	0.32	Vp-p	
R chroma ratio		R/BN	Level ratio between R and burst in Fig. 5	C	2.84	3.16	3.48		
R phase		θ_R	R phase in Fig. 5	C	94	104	114	deg	
G chroma ratio		G/BN	Level ratio between G and burst in Fig. 5	C	2.65	2.95	3.25		
G phase		θ_G	G phase in Fig. 5	C	231	241	251	deg	
B chroma ratio		B/BN	Level ratio between B and burst in Fig. 5	C	2.01	2.24	2.47		
B phase		θ_B	B phase in Fig. 5	C	337	347	357	deg	
PAL burst level ratio		K(BP)	Burst level ratio between S4 ON, PAL and PAL in Fig. 5	C	0.9	1.0	1.1		

Item	Symbol	Conditions	Test point	Min.	Typ.	Max.	Unit
PAL burst phase	θ_{PAL}	Burst phase of S4 ON, PAL in Fig. 5	C	125	135	145	deg
	$\theta_{\overline{PAL}}$	Burst phase of S4 ON, \overline{PAL} in Fig. 5	C	215	225	235	
Burst width	tW(B)	Fig. 5	C	2.5	2.75	3.6	μ S
Burst position	tD(B)	Fig. 5	C	0.45	0.5	0.75	μ S
Carrier leakage	V _L	Fig. 5	C			20	mVp-p
Composite sync output voltage	V _{o(S)}	Fig. 7	B	0.2	0.29	0.4	Vp-p
Audio buffer	Voltage gain	G _{v(A)} V _{IN} = 1.0Vp-p, f = 1kHz, Fig. 6	A	-1.0	0	1.0	dB
	Frequency response	f _{c(A)} Frequency when an output becomes -3 dB with the output of f = 1 kHz in Fig. 6 set to 0 dB.		30			kHz
	Distortion factor	THD V _{IN} = 1.0Vp-p, f = 1kHz, Fig. 6				1.0	%

Electrical Characteristics Test Circuit

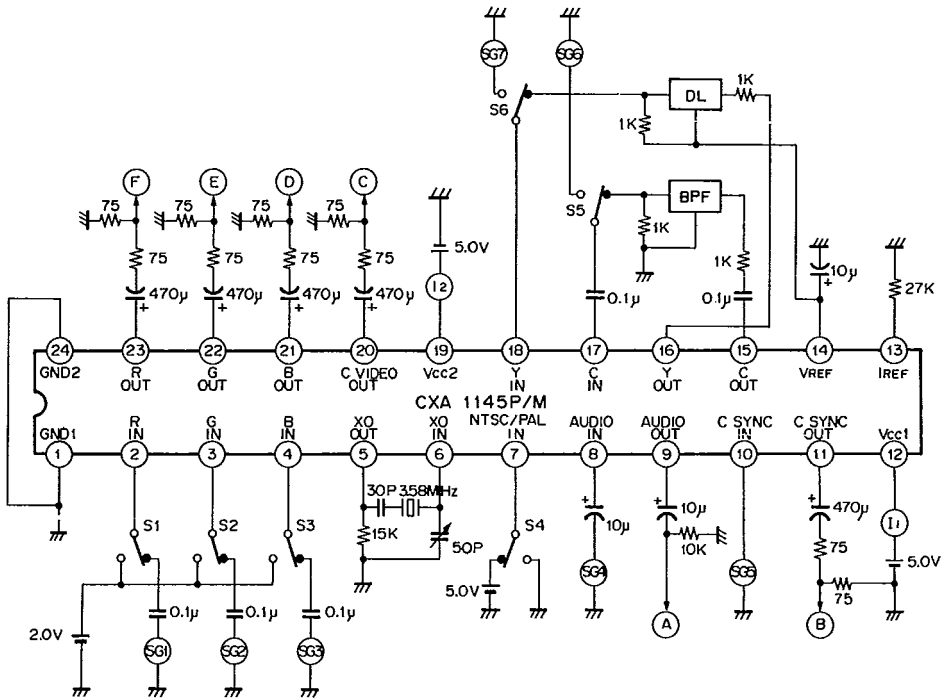

Test Signal

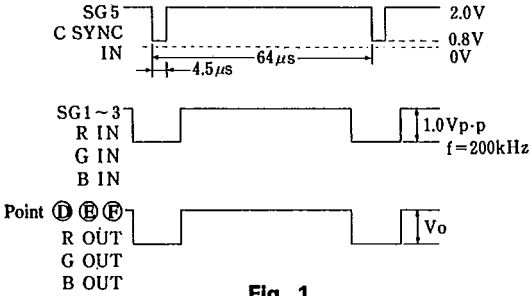

Fig. 1

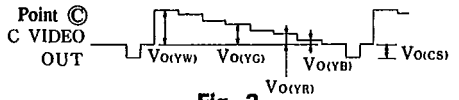
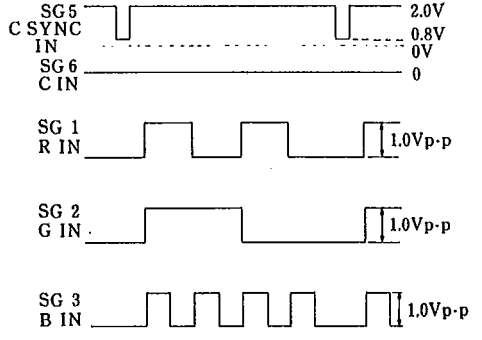

Fig. 2

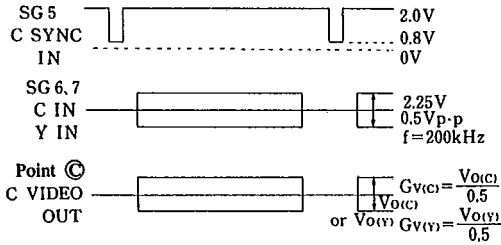

Fig. 3

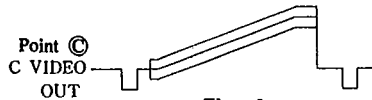
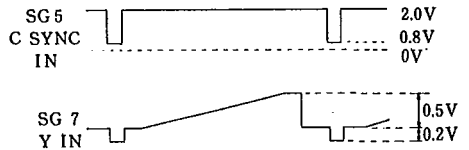

Fig. 4

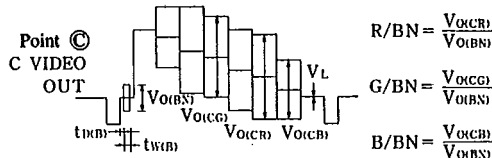
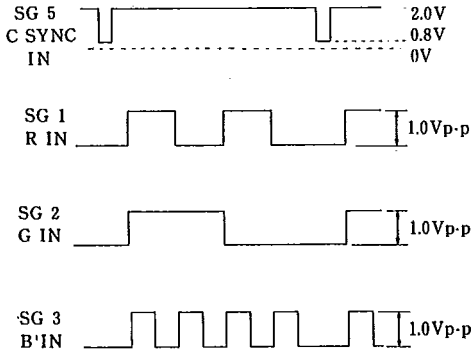

Fig. 5

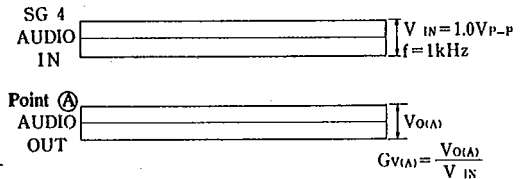

Fig. 6

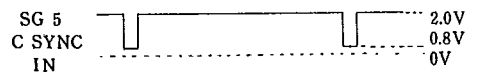
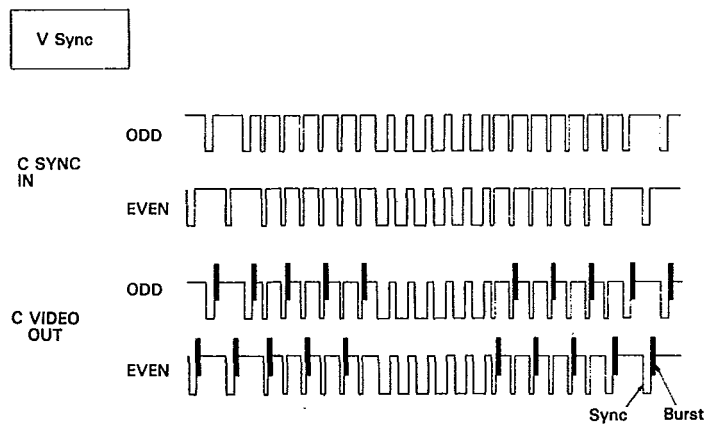
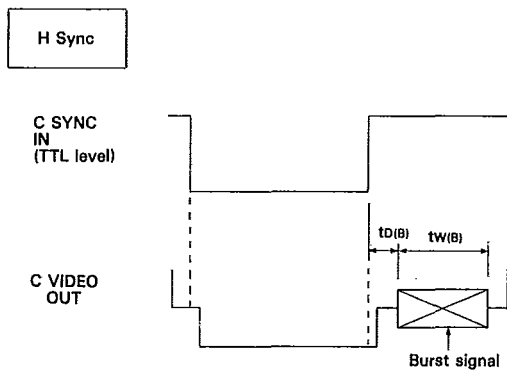

Fig. 7

Burst Signal

CXA1145P/M generates the burst signal in the timings below following an input composite sync.



Application Circuit (NTSC mode)

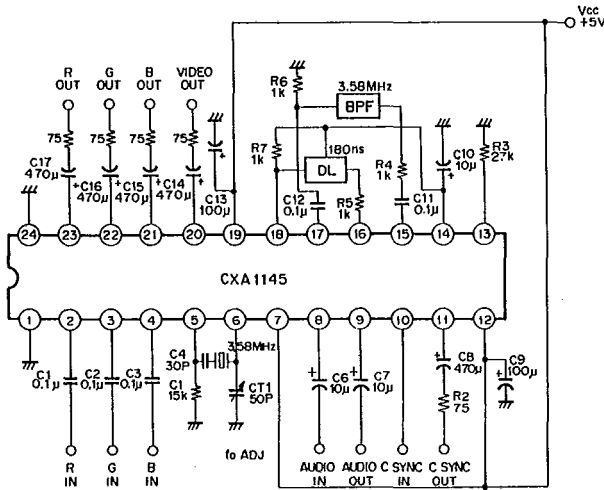

< How to supply subcarrier externally >

When a subcarrier is added externally, this section will be as follows:

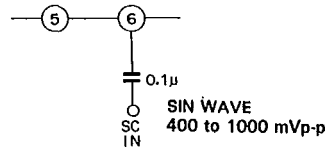

< How to adjust the oscillation level >

Regulating the trimmer capacitor, set XO out level between 400 to 1000 mVp-p.

* Metal film resistor $\pm 1\%$

BPF: Toko H287BSJS-3108HWD
DL: Matsushita ELB-5F020N

Application Circuit (PAL mode)

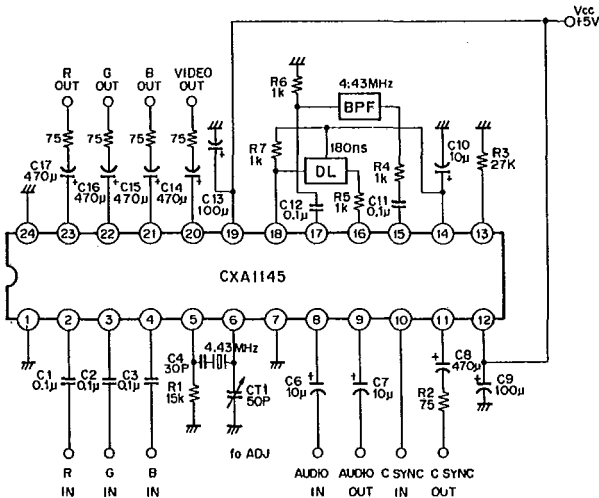

< How to ... >

When a subcarrier is added externally, this section will be as follows:

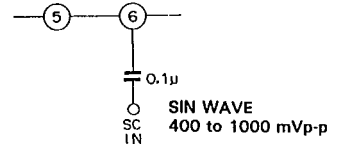

< How to adjust the oscillation level >

Regulating the trimmer capacitor, set XO out level between 400 to 1000 mVp-p.

* Metal film resistor $\pm 1\%$

BPF: Toko H287BSJS-3108HWD
DL: Matsushita ELB-5F020N

< How to set to NTSC/PAL modes >

To set to NTSC/PAL modes, connect CXA1145P's pin 7 to 9 either Vcc (supply pin) or GND. Connection to Vcc produces NTSC mode, and to GND PAL mode. This is executed by connecting the jumper line of the desired mode on the evaluation board.

CXA1145P Evaluation Board Pins Description

Symbol	Description
R IN G IN B IN	Input pin of the analog RGB signal
SC IN	Pin for the external supply of the subcarrier. For the connection in this case. See the subcarrier external supplying method. SCIN = 400 mVp-p to 1000 mVp-p
AUDIO IN	Input pin of the audio buffer amplifier
AUDIO OUT	Output pin of the audio buffer amplifier
C SYNC IN	Input pin of the composite sync signal C SYNCIN = TTL level ($L \leq 0.8V$, $H \geq 2.0V$)
C SYNC OUT	Output pin of the composite sync signal
R OUT G OUT B OUT	Output pin of the analog RGM signal
VIDEO OUT	Output pin of the composite video signal
Vcc	Supply Vcc = 5V
GND	GND pin

Evaluation PC board pattern arrangement diagram

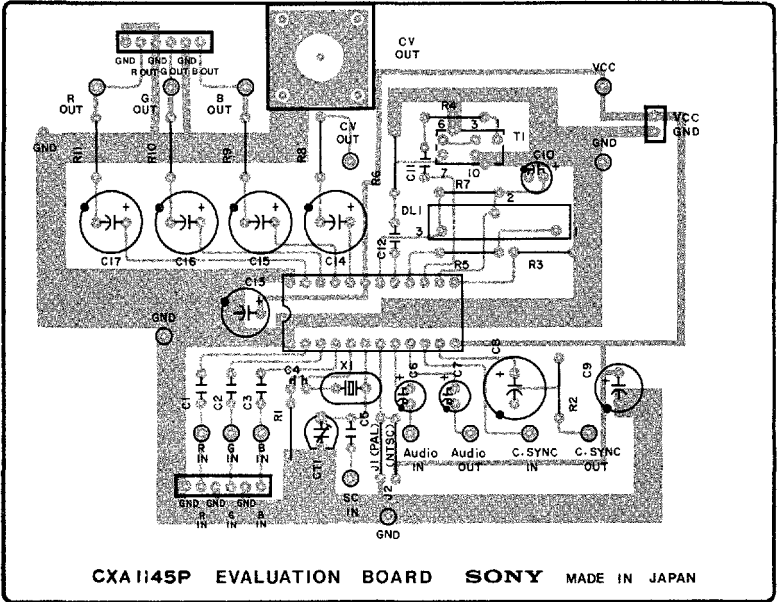

Parts arrangement diagram (parts side)

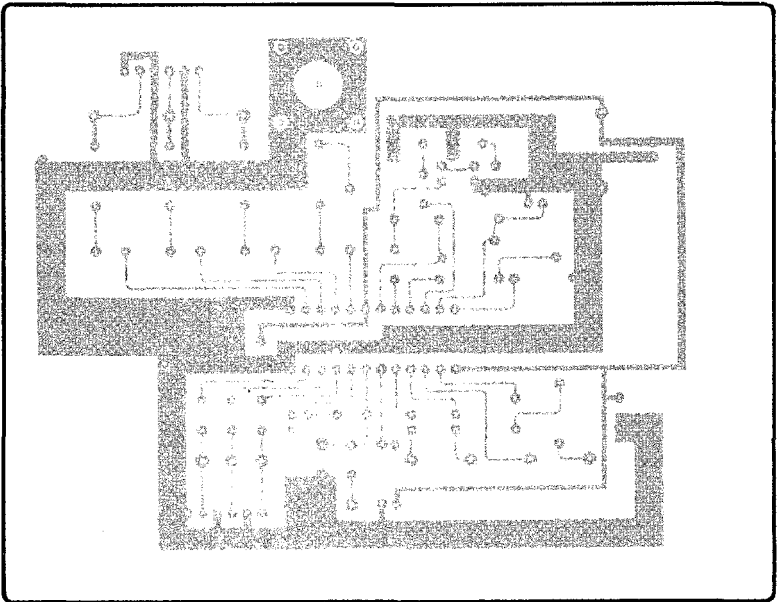

Pattern diagram (reverse side)

RGB output voltage temperature characteristics

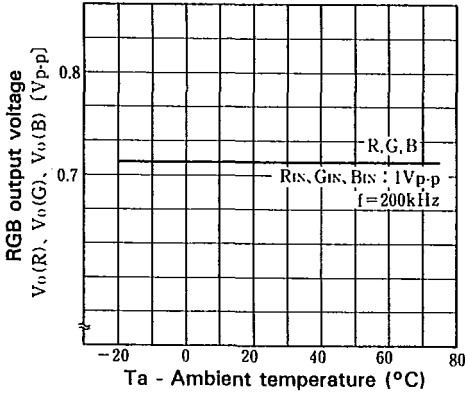

Burst signal level temperature characteristics

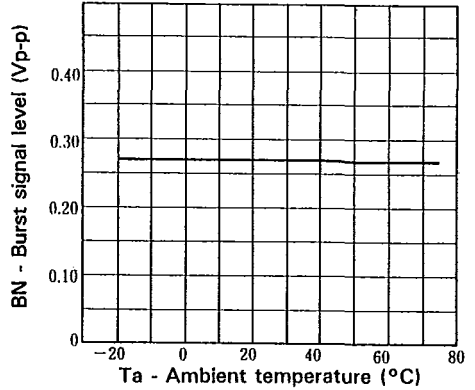

Chroma ratio temperature characteristics

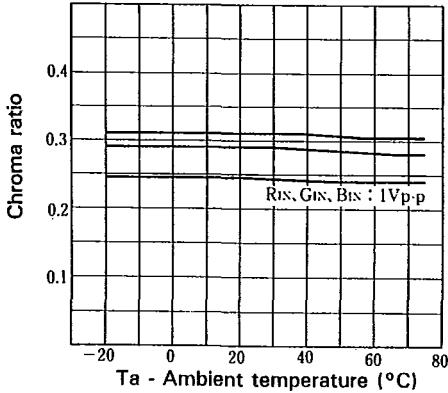

Composite sync signal output voltage temperature characteristics

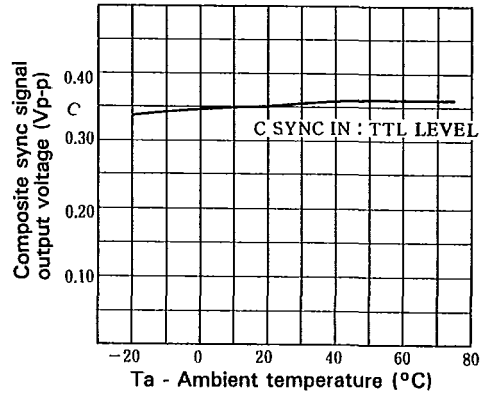

$$\begin{aligned} B/BN &= \frac{V_o(CB)}{V_o(BN)} & R/BN &= \frac{V_o(CR)}{V_o(BN)} & G/BN &= \frac{V_o(CG)}{V_o(BN)} \end{aligned}$$

Audio buffer amplifier distortion factor temperature characteristics

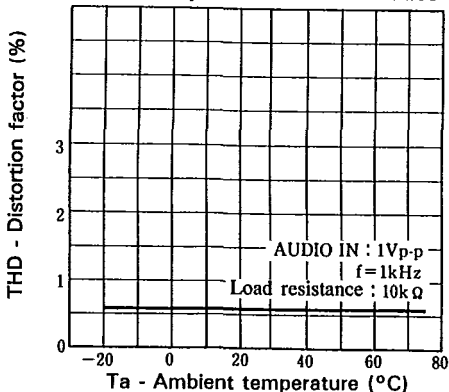

Audio buffer amplifier voltage gain temperature characteristics

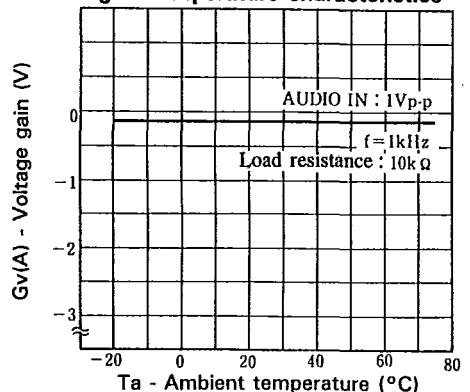

**Audio buffer amplifier
frequency characteristics**

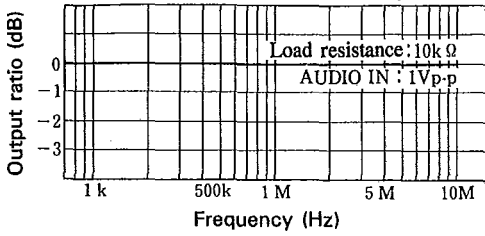

**RGB output frequency
characteristics**

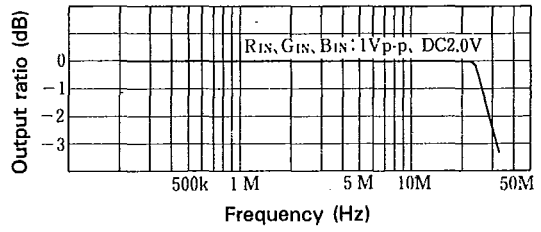

Note) For details refer to the test signals in the Electrical Characteristics Test Circuits.